



FUSION

ecosmar⁺
Fire

Synonymous with its name, the Fusion fireplace blends style with function. With its streamlined, uncluttered lines, the Fusion is both smart and modern, and designed to enhance most contemporary surrounds. Boasting minimalist chic and maximum practicality, the Fusion features a double opening with a 'see through' effect, creating a sense of space.

Essentially a rectangular-shaped fireplace, the Fusion offers much more. It is a stylish, freestanding piece of furniture designed to accept the EcoSmart Burner. The Fusion comes with a rear toughened glass panel and Wind Screen Static that's affixed to the front of the firebox.

The perfect accoutrement for contemporary living, the Fusion fireplace is ideal for installation in apartments, houses and commercial premises such as bars and restaurants.

The Fusion, like all models in the Designer Range, is a fully portable work of art and is fuelled by Bioethanol, an environmentally friendly, renewable energy. If your looking for a larger version of the Fusion, then the EcoSmart Vision is a similar-styled model, in a wider surround.

Designer	Paul Cohen
Dimensions	H 990mm W 945mm D 450mm H 39in W 37.2in D 17.7in
Weight	58.7kgs, 129.4bs
Materials	Brushed Stainless Steel, Toughened Glass, MDF
Colours	Black & White (Standard) Custom colours* can be matched <small>*Swatch of the colour and the colour composition to be supplied. Additional cost will apply.</small>
Application	Indoor
Compatible Burners	BK Series

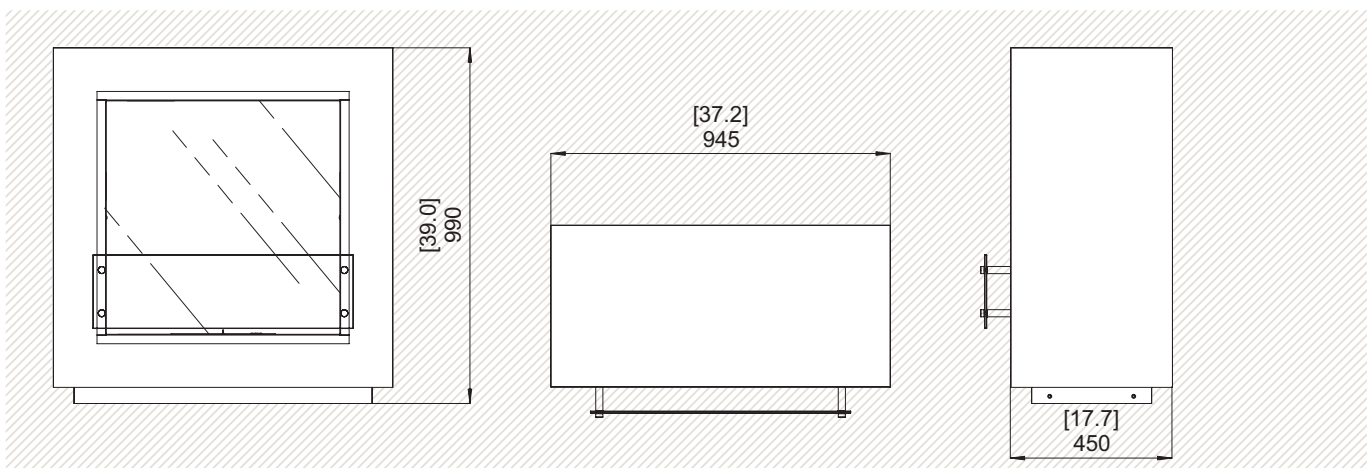

Clearances & Installation

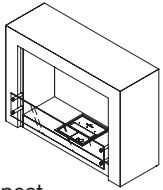

Aspect
56.7kgs, 125lbs

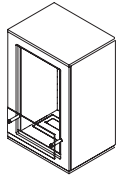

Citi
48.8kgs, 107.6lbs

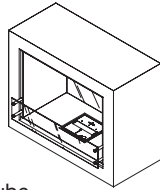

Cube
49.2kgs, 108.5lbs

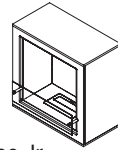

Cube Jr
59.8kgs, 131.8lbs

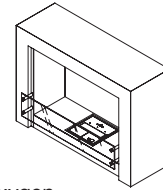

Oxygen
66.2kgs, 146lbs

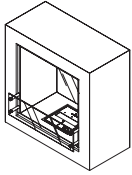

Fusion
58.7kgs, 129.4lbs

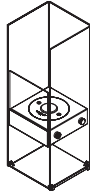

Ghost
38kgs, 83.9lbs

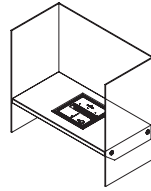

Igloo
89kgs, 196.2lbs

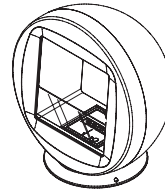

Q
57.1kgs, 125.9lbs

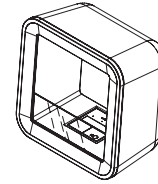

Retro
41.1kgs, 90.6lbs

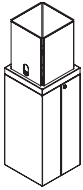

Tower
46.6kgs, 102.7lbs

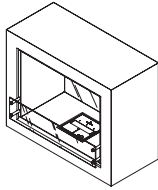

Vision
76kgs, 167.6lbs

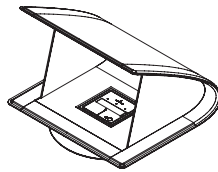

Zeta
66.3kgs, 146.2lbs

DESIGNER RANGE CLEARANCES

Ensure that the mouth of the flame is positioned a minimum of 1500mm [59.1in] away from curtains, flammable materials and other sources of ignition. Be aware of drafts.

WARNING: Keep fire at least 1500mm [59.1in] away from any combustibles.

Aspect, Citi, Cube, Cube Jr, Oxygen, Zeta

There are no additional requirements for side and/or overhead clearances.

Igloo, Ghost

There must be a minimum of 1500mm [59in] between the mouth of the flame and the nearest combustible at all times.

Vision, Fusion

The Vision/Fusion is designed as a room divider but can also be placed against any flat wall surface made out of non-combustible material or sitting 100mm [3.95in] away from any wall of any material. Always place the glass side closest to the wall. Even when unit is used as a room divider, the glass side is the "rear."

Tower, Q, Retro

When used indoors there must be a minimum of 1500mm [59.1in] between the mouth of the flame and the nearest combustible at all times. Make sure your fire is at least this distance away from curtains, etc. Be aware of drafts.

When used outdoors it is important that the model be positioned in a large open space ensuring that the nearest combustible (trees, branches, umbrellas, ceilings etc) are a minimum of 2000mm [78.74in] away in all weather conditions (for example, on windy days where there is movement in branches, the clearance must still be met).

When not in use it is recommended that you protect the model from water damage or corrosion by covering. Burner covers are available.

Clearances & Installation

VISION, FUSION

Note: The Vision/Fusion is heavy - you will need two (2) people to perform this procedure.

Equipment required: pencil, phillips head screw driver, drill.

1. Underneath the Vision/Fusion there is a removable locking base, to access it, remove the nylon feet, locate and remove the plugs and screws found on all sides of the skirting.
2. Confirm that you have received all necessary parts as illustrated.
3. Lift the Vision/Fusion up and away.
4. Position the removed locking base into the desired location ensuring that the mouth of the flame is positioned a minimum of 1500mm [59.1in] away from curtains, flammable materials and other sources of ignition. Mark the pre-drilled holes with a pencil (ensure clearances are for the entire model, not just the locking base).
5. Remove the locking base and drill holes in the centre of the positions marked; Using the screws supplied (A for Timber, B for Concrete), fix the locking base into position.
6. Position the Vision/Fusion over the secured locking base and lower so it locks into position.
7. Screw the Vision/Fusion and the locking base back together by replacing the screws and plugs removed in step 1 (do not replace the nylon feet).

WARNING: Fire hazard. Do not remove the rear glass panel. Air flow could push flames out the front or rear of the fireplace. The glass used in the Firebox is toughened glass which means it is stronger than normal glass and can withstand high temperature variations. Importantly, even though it is stronger, toughened glass still has weaknesses. The corners and sides are specific pressure points where it is more fragile and can break if care is not taken.

NOTICE: Handle glass with care. If glass is cracked or damaged, do not use range until glass is replaced.

In the case of breakage, toughened glass will shatter into small crystal-like pieces which can cause potential injury and be a choking hazard for small children. We advise that the glass should be handled with special care and that operation of the product should cease immediately if a fault is found. Glass broken due to mishandling is not covered by warranty.

